



RELAY G10TII / G10 / G10S

PILOT'S GUIDE ►

Supplier's Declaration of Conformity
47 CFR § 2.1077 Compliance Information

Unique Identifiers: Line 6® Relay® G10TII, Line 6 Relay G10, Line 6 Relay G10R, Line 6 Relay G10S,
Line 6 Relay G10SR

Responsible Party - U.S. Contact Information:

Yamaha Guitar Group, Inc.
26580 Agoura Road
Calabasas, CA 91302-1921
(818) 575-3600
<https://line6.com/>

FCC Compliance Statement:

This device complies with Part 15 of the FCC Rules. Operation is subject to the following two conditions: (1) This device may not cause harmful interference, and (2) this device must accept any interference received, including interference that may cause undesired operation.

FCC ID: UOB-G10TII
IC: 6768A-G10TII

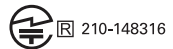

© 2021 Yamaha Guitar Group, Inc. All rights reserved.

Line 6, the Line 6 logo, and Relay are trademarks or registered trademarks of Yamaha Guitar Group, Inc. in the U.S. and/or other jurisdictions.

System Overview

- Wireless freedom in any size venue, home, or office
- Easy to use—no setup required
- Automatically chooses the best channel for true playing freedom
- Up to 7 hours of playing time per charge
- Optional manual channel selection for setups with multiple wireless units (Relay G10S and select Relay-Ready products)
- Best in class sound quality provided by:
 - 24-bit uncompressed digital transmission
 - Best in class DAC and ADC provide super low noise transmission (better than 110dB dynamic range)
- Up to 50 feet (15 meters) for Relay G10, or up to 130 feet (40 meters) for Relay G10S, line-of-sight range

2.4GHz Wireless

Since the Line 6 Relay is a 2.4GHz wireless system, please avoid placing the receiver next to other RF transmitting equipment. We recommend that you install the G10 or G10S receiver at least 10 feet (3 meters) away from RF transmitters (e.g., WiFi routers).

The Relay system automatically selects the best channel when the transmitter is docked (for the G10S receiver, its Channel Selector needs to be set to **AUTO**).

After changing WiFi or other 2.4GHz wireless channels, please dock the transmitter in the receiver for at least 10 seconds.

What's in the Box

RELAY G10TII

- Relay G10TII Transmitter
- Pilot's Guide and End User License Agreement



RELAY G10

- Relay G10TII Transmitter (not included in G10R Receiver Separate)
- Relay G10 Receiver
- USB-A to Micro USB-B cable
- Universal USB Power Supply (5V-1A) kit with international AC adapter kit (manufacturer: Hon-Kwang Electric Co., Ltd. and model: HK-AP-050AZZZ-CP [zzz=001 to 100]). The provided AC adapter serves as the disconnect device
- Pilot's Guide and End User License Agreement

RELAY G10S

- Relay G10TII Transmitter (not included in G10SR Receiver Separate)
- Relay G10SR Receiver

- 9V DC Power Supply (manufacturer: Shenzhen JingQuanHua & Everrise Intelligent Electric Co. Ltd. and model: NSA5Ex-090050)
- USB-A to Micro USB-B Cable
- Pilot's Guide and End User License Agreement

  Please refer to the additional included safety documentation for power supply information.

 (Direct current)

Getting Started

Using the Relay G10TII Transmitter with a Relay G10 or G10S Receiver

1. **Insert the Relay G10TII transmitter all the way into the receiver dock to allow the battery to charge.** A green steady LED on the transmitter indicates the transmitter is fully charged. A full charge takes approximately 3 hours.
2. **While the G10TII is docked in the receiver, the system scans the environment and automatically selects the optimal wireless channel.**

The G10S receiver's channel selector must be set to **AUTO** for this step.

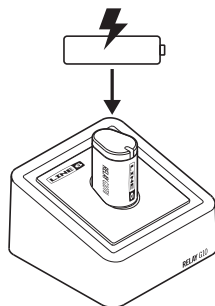

Relay G10

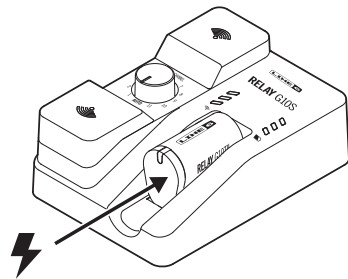

Relay G10S

3. **Insert the G10TII transmitter into your instrument.**

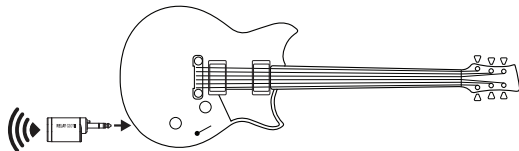

4. Connect the receiver to a power source using the power adapter provided with your device. Connect the Relay G10 or G10S receiver's 1/4" Instrument Output into an amp or FX unit.

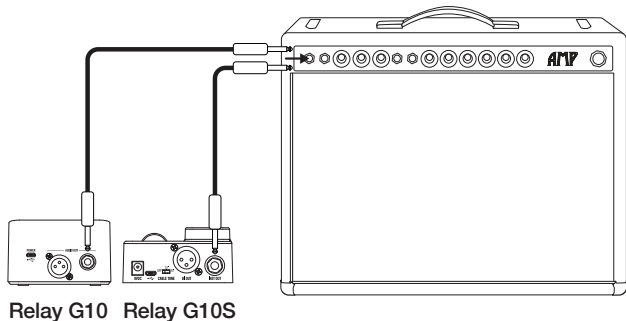

5. For use as a DI with bass and acoustic guitars, connect the Relay G10 or G10S receiver's XLR DI Out to a mixer or audio interface.

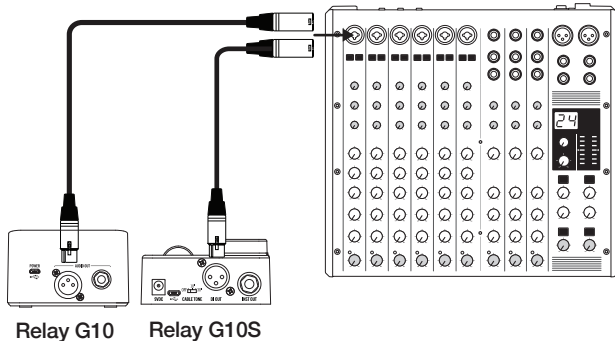

Using a Relay G10TII Transmitter with Relay-Ready Devices

In addition to being compatible with Line 6 wireless receivers, the Relay G10TII transmitter also works with a number of select Relay-Ready devices. Please see <https://line6.com/g10info/> for more info.

To use G10TII with your Relay-Ready device, please see the following steps.

1. Power your Relay-Ready device on and insert the Relay G10TII into the input jack.

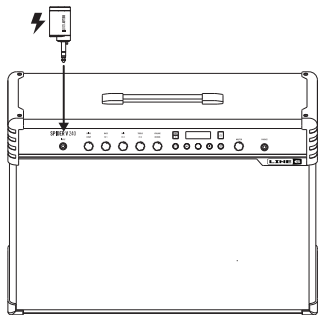

The Relay-Ready device charges the G10TII transmitter, as well as scans the environment, and automatically selects the optimal wireless channel and frequency.

2. Once fully charged, insert the G10TII transmitter into your instrument. Please refer to the documentation of your Relay-Ready product for additional details.

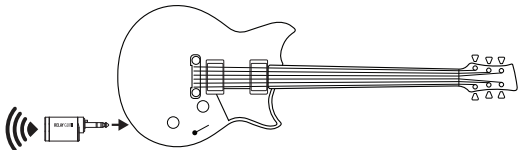

Relay G10TII Transmitter Details

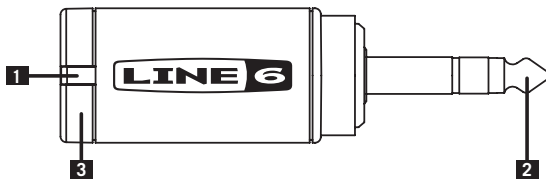

1. **Battery Status** - This LED illuminates green when the transmitter is powered on and while more than 30 minutes of operating time remains. The LED flashes red when less than 30 minutes of operating time remain—also see [“Important Information About the G10TII Transmitter”](#) on [page 6](#) for additional LED states.

When the transmitter is plugged into the receiver for charging, a flashing red LED indicates less than 30 minutes of battery operation, a flashing green LED indicates more than 30 minutes of battery operation, and a steady green LED indicates a fully charged transmitter. A full charge takes approximately 3 hours.

2. **1/4" Plug** - Plugs into instrument.
3. **Antenna** - The calibrated internal antenna avoids damage or deformity in normal use. Avoid covering the antenna area with metallic fabrics or accessories, and avoid direct contact with parts of the performer's body for best results.

Sleep Mode - To extend battery life, sleep mode is activated after a period of 4 minutes where no audio input is detected. The transmitter “wakes up” automatically when the instrument is played.

Important Information About the G10TII Transmitter

- The recommended charging temperature range of the G10TII transmitter is specified as 50° F to 86° F (10° C to 30° C).
- The recommended operating temperature range of the G10TII transmitter is specified as 32° F to 122° F (0° C to 50° C).
- Line 6 recommends charging the G10TII transmitter at least every 6 months, based on best practices for lithium-ion batteries.

G10TII Transmitter (docked in receiver)*	
LED State	Condition
Red (slow flash)	Charging, less than 30 minutes battery time remaining [†]
Green (slow flash)	Charging, more than 30 minutes battery time remaining
Green (solid)	Fully charged [‡]
Dim Red/Pink, may turn off	G10TII is not docked properly— Try un-docking and re-docking
Red (three quick flashes)	G10TII charging has stopped due to being outside the supported temperature range—Charging will resume after 5 minutes at 50° F to 86° F (10° C to 30° C) [§]
Orange (solid)	Docked and connected to Mac or PC, firmware update in progress
Off	Receiver not powered (transmitter enters sleep mode after 4 minutes if receiver power is disconnected)

G10TII Transmitter (connected to instrument)	
LED State	Condition
Green (solid)	Transmitting, more than 30 minutes battery time remaining
Red (slow flash)	Transmitting, less than 30 minutes battery time remaining
Off	Connected to an instrument but not enough remaining battery power to transmit or removed from instrument

*When the G10TII is docked in a receiver or Relay-Ready device, the G10TII LED initially indicates amber, red, or green, depending on its current battery state. This is followed by four flashes (red) as the device initializes. Once this completes, the G10TII LED proceeds to indicate its remaining battery time.

†All values stated for amount of battery time remaining are approximate, and the exact amount of battery time remaining when an LED state is indicated may vary slightly between charges. When the G10TII flashes red, it may have up to 60 minutes of battery time remaining.

‡If the G10TII reaches a full charge (solid green) and remains docked, the G10TII LED may eventually flash green again. This is expected behavior as the G10TII may discharge slightly after reaching a full charge, and its LED may then flash green until it again reaches a full charge.

§If the lockout indication continues for over 10 minutes, please stop charging and try again in a cooler environment condition.

||When the G10TII has insufficient power to transmit, its LED may indicate a pattern of five quick red flashes when connected to an instrument and audio is detected. This is the expected behavior.

Relay G10 Receiver Details

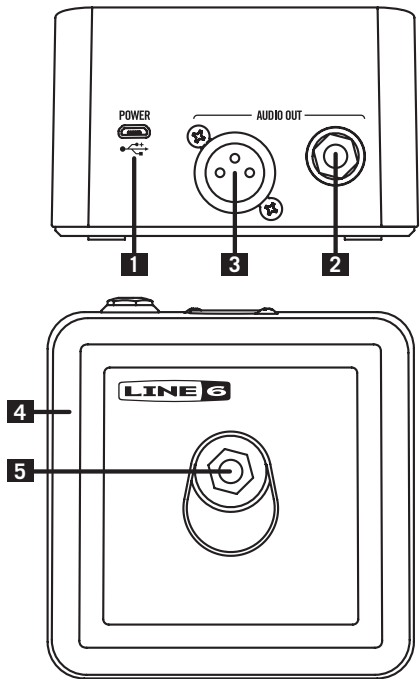

1. **Micro USB** – Use for primary DC (5V DC /1A) power and firmware updates.
2. **Output A** – 1/4" unbalanced, full performance output intended to drive a guitar/bass amplifier, stomp box, or multi-effects input.
3. **Output B** – XLR balanced, full performance output intended to connect to a mixing console, PA system, audio interface, or similar.
4. **LED Halo** – Multicolor LED halo displays the status for the transmitter battery and radio. The halo illuminates white when receiving a good radio signal from a G10T or G10TII transmitter. The halo pulses red when the transmitter's battery is below 30 minutes of operating time. A white pulsing halo indicates that no signal is received from the transmitter.*
5. **Transmitter Input** – Plug in the transmitter here for charging and channel selection.

 ***NOTE:** Please also see [“G10 Receiver Information”](#) on [page 9](#) for details regarding the system's LED states.

G10 Receiver Information

G10 Receiver (G10T or G10TII transmitter docked)	
LED State	Condition
White (solid)	G10T or G10TII charging or fully charged
White (flicker)	System has auto-scanned and is changing its channel
Red (flash)	G10T or G10TII not docked properly— Try un-docking and re-docking
Pink (pulse)	Connected to Mac or PC, Line 6 Updater open
Pink (solid)	Connected to Mac or PC, firmware update in progress
Off	No power to receiver

G10 Receiver (G10T or G10TII transmitter un-docked)	
LED State	Condition
White (solid)	Transmission received, more than 30 minutes of runtime
Red (slow flash)	Transmission received, less than 30 minutes of runtime
White (pulse)	Receiver on, but no transmission received
White (flicker)	Transmission dropout (RF mute)
Off	No power to receiver

Relay G10S Receiver Details

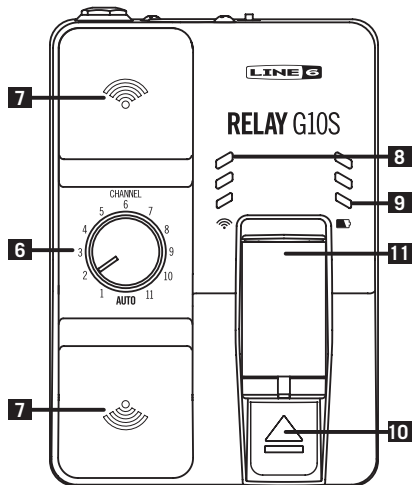
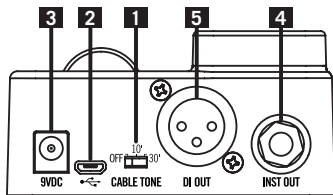

1. **Cable Tone** - When an instrument is connected to a pedal or amp with a cable, the cable alters the sound, depending on the cable's length. Cable Tone adds a 10 feet or 30 feet cable emulation to the sound.
2. **Micro USB** - Use for firmware updates or optional power.
3. **9V DC Power** - Use for primary DC (9V DC / 500mA) power. The provided AC adapter serves as the disconnect device.
4. **Instrument Output** - Connect to the input of a guitar pedal or amplifier.
5. **XLR DI Output** - Balanced XLR output for connection to a mixing desk, audio interface, powered speaker, or similar with DI level.
6. **Channel Selector** - With the G10T or G10TII transmitter docked in the receiver, set to **AUTO** for automatic channel selection. Or, with the transmitter docked in the receiver, set to a channel number to select a fixed channel. This is recommended when several wireless units are in use.
7. **Antennas** - Diversity antennas receive the RF signal from the transmitter. Please make sure that the antennas are not covered.
8. **RF LEDs** - 3 LEDs indicate the RF signal quality.*
9. **Battery LEDs** - 3 LEDs indicate the amount of battery life while the G10T or G10TII is docked or in use.*

***NOTE:** Please see “G10S Receiver Information” on page 12 for details regarding the system’s LED states.

- 10. Release Latch** - Keeps the G10T or G10TII in a secure transport position. To remove the transmitter, push down on the latch while pulling the transmitter out.
- 11. G10T or G10TII Transmitter, Docked** - With the G10T or G10TII transmitter docked, the battery is charged and the channel is set on the transmitter.

With the Channel Selector set to **AUTO**, the G10S receiver performs a scan and automatically sets the receiver and transmitter to the best available channel.

To store and transport the Relay G10S system - Pull the G10T or G10TII transmitter out to the first click so that it is powered off and the battery cannot discharge.

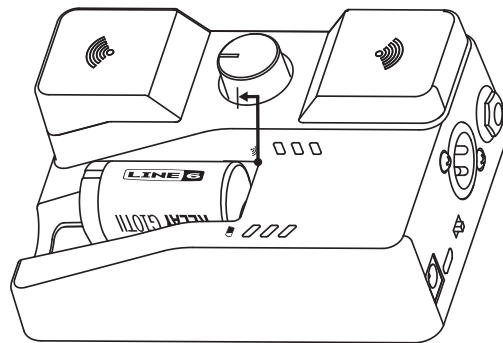

G10S Receiver Information

G10S Receiver (G10T or G10TII transmitter docked)		
LED State		Condition
Battery LEDs	Green (cycle 1-2-3)	G10T or G10TII charging
	3 Green LEDs (solid)	G10T or G10TII fully charged
RF LEDs	3 Red LEDs (solid)	More than 75% interference (not usable)
	2 Red LEDs (solid)	50% interference (usable, but only for short range)
	1 Red LED (solid)	25% interference (usable, also indicates G10S power on)
Battery LEDs Off RF LEDs On	Battery LEDs—Off RF LEDs—Red (cycle 3-2-1)	G10T or G10TII not docked properly—Try un-docking and re-docking.
	Battery LEDs—Off RF LEDs—3 Red LEDs (solid)	Connected to Mac or PC, Line 6 Updater application open
All LEDs Off		No power to receiver

G10S Receiver (G10T or G10TII transmitter un-docked)

LED State		Condition
Battery LEDs	3 Green LEDs (solid)	Transmission received, more than 4.5 hours of runtime
	2 Green LEDs (solid)	Transmission received, more than 3 hours of runtime
	1 Green LED (solid)	Transmission received, more than 1.5 hours of runtime
	1 Red LED (solid)	Transmission received, more than 30 minutes of runtime
	1 Red LED (flash)	Transmission received, less than 30 minutes of runtime
RF LEDs	3 Green LEDs (solid)	Transmission received, good signal strength
	2 Green LEDs (solid)	Transmission received, average signal strength
	1 Green LED (solid)	Transmission received, poor signal strength
	3 Red LEDs (solid)	No transmission received, more than 75% interference (not usable)
	2 Red LEDs (solid)	No transmission received, 50% interference (usable, but only for short range)
	1 Red LED (solid)	No transmission received, 25% interference (usable, also indicates G10S power on)
	Red (cycle 3-2-1)	G10S channel knob has been changed from its setting since G10T or G10TII was last docked
All LEDs Off	No power to receiver	

